

# BALTIC G

GE Infusion

Baltic G adjustable LED spotlight with GE Infusion light engine, interchangeable reflectors, integral 1-10v dimmable driver, and finished white (RAL 9010). Suitable for track mounting, universal 3 circuit type adaptor comes as standard.

To specify please choose the required Colour Temperature (K) and Colour Rendering Index (CRI - Ra). Then choose the reflector beam angle. Reflector holder Type A comes with the body assembly and has interchangeable reflectors as shown. One reflector comes with the spotlight and is the clients choice. Additional reflectors can be ordered separately.

Examples:  
 D4000/188310 plus D5000 is Baltic G 4000K, Ra95 with 15° narrow beam reflector.  
 D4500/214210 plus D5200 is Baltic G 2700K, Ra80 with 36° wide beam reflector.

Product No	Engine No	Luminous Flux (lms)	Colour Temp	CRI	Power (w)	IP
2 step MacAdam						
D4000 /	188310	1885	3000K	Ra87	27	20
4 step MacAdam						
D4500 /	214210	2140	2700K	Ra80	27	20
D4500 /	229310	2295	3000K	Ra80	27	20
D4500 /	245510	2455	4000K	Ra80	27	20

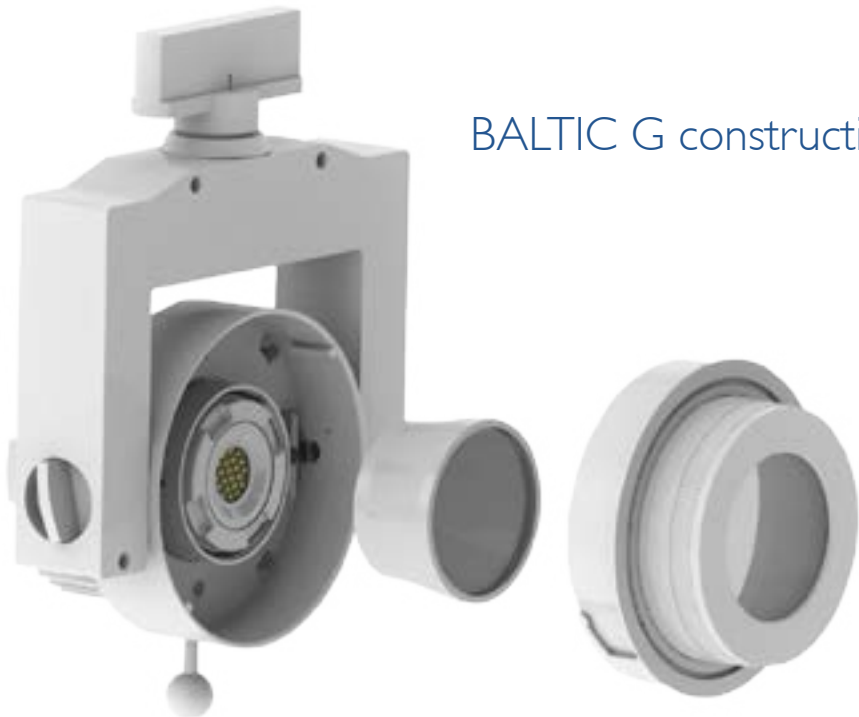
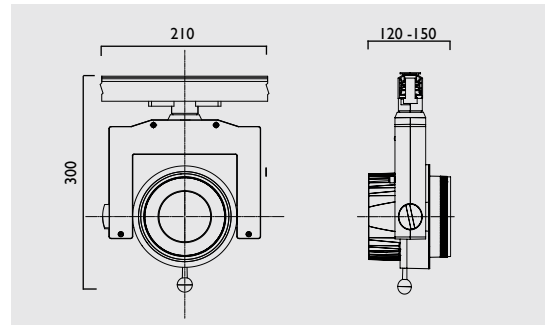

BALTIC G construction

## Reflector holder Type A



Medium  
D5100



Wide  
D5200



Flood  
D5300

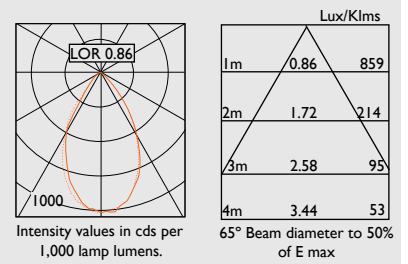
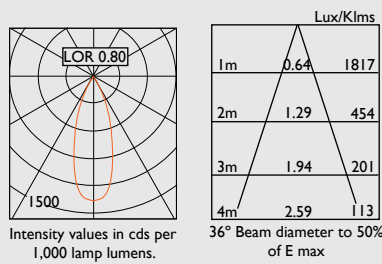
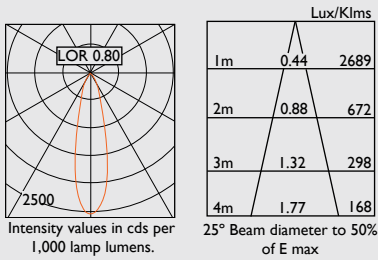

Spot reflector complete with reflector holder

D5000

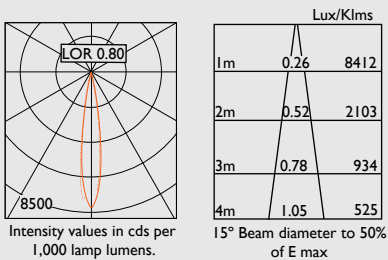

## Reflector Options

Product No	Beam Angle	Reflector
D5000	15°	Narrow
D5100	25°	Medium
D5200	36°	Wide
D5300	65°	Flood

## Attachments

Product No

D3700

Barn Doors

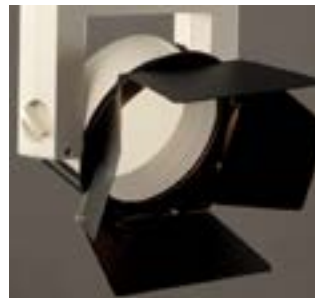

Barn Doors, D3700 only suitable for reflector holder type A