

LIGHTLINE LED 60

SURFACE / PENDANT

LIGHTLINE LED 60 can be surface mounted or suspended from the ceiling. It consists of an aluminium extruded profile constructed as individual modules in various chassis lengths, which come complete with integral driver. Optical control is provided by a clip in opal diffuser.

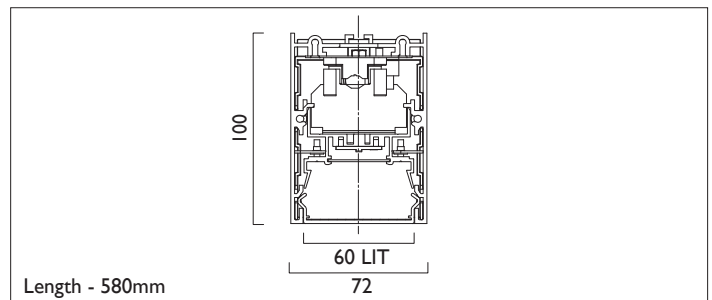
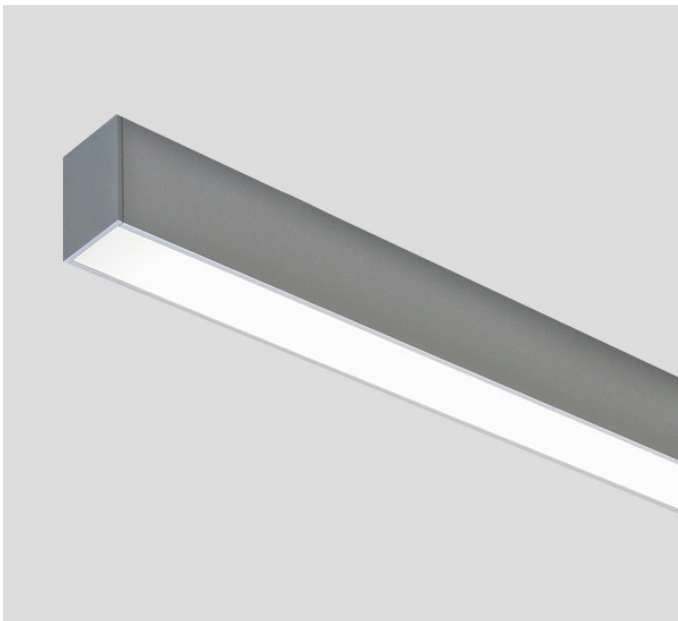

Product Number	L I 202
Lamp Type	LED, 2260 lumens, 3000K, Ra>80, 15.6W
Construction	Aluminium / Steel / Plastic
Diffuser	Opal
Ceiling Trim	White RAL 9010
IP	IP40
Control	Driver

EN 60598-1
WEE/AE0290TY

