



# LIGHTLINE LED 60

LIGHTLINE LED 60 is suitable for recess mounting in most ceiling types. It consists of an aluminium extruded profile with white RAL 9010 ceiling trim as individual modules in various chassis lengths, and comes complete with integral driver.

Optical control is provided by a clip in opal diffuser.

High Efficient LED. Small tolerance of MacAdam 3. Long life 72,000 hours.

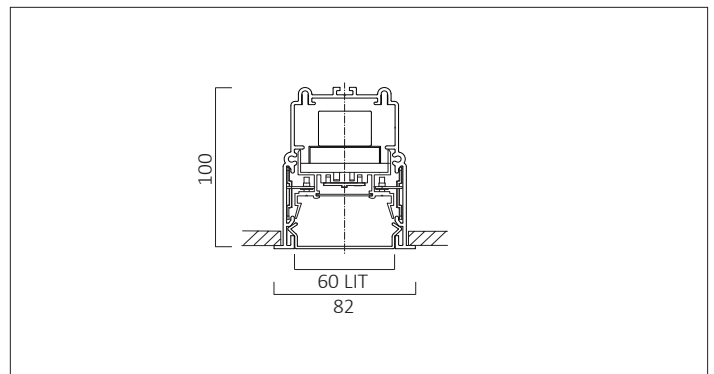
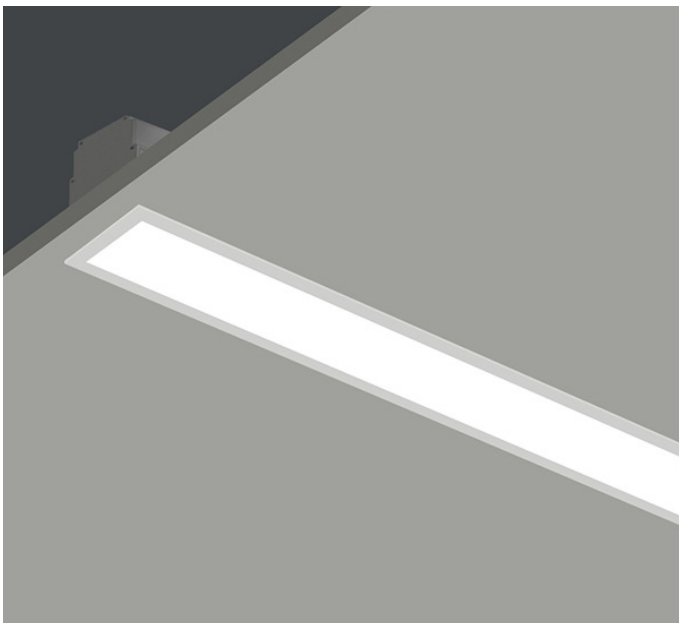

Construction	Aluminium / Steel / Plastic
Diffuser	Opal
Ceiling Trim	White RAL 9010
IP	IP40
Control	Fixed, DALI, 1-10V

Product No	Length (mm)	Colour Temp	CRI	Source (Lm)	Wattage (W)	Current (mA)	System Efficacy (Lm/W)	Luminaire Efficacy (LLm/W)	Cut Out (mm)
<b>L1402</b>	590	3000K	>80	1170	7.2	300	162	98	73 x 581
<b>L1403</b>	870	3000K	>80	1755	10.8	300	162	98	73 x 861
<b>L1404</b>	1150	3000K	>80	2340	14.4	300	162	98	73 x 1141
<b>L1405</b>	1430	3000K	>80	2925	18.0	300	162	98	73 x 1421
<b>L1406</b>	1710	3000K	>80	3510	21.6	300	162	98	73 x 1701
<b>L1502</b>	590	4000K	>80	1220	7.2	300	170	102	73 x 581
<b>L1503</b>	870	4000K	>80	1830	10.8	300	170	102	73 x 861
<b>L1504</b>	1150	4000K	>80	2440	14.4	300	170	102	73 x 1141
<b>L1505</b>	1430	4000K	>80	3050	18.0	300	170	102	73 x 1421
<b>L1506</b>	1710	4000K	>80	3660	21.6	300	170	102	73 x 1701

Tolerance range for optical and electrical data: ±10 %.  
Other outputs are available.