

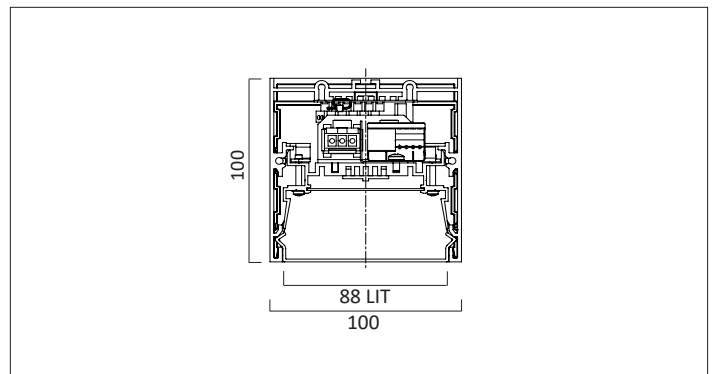

LIGHTLINE LED 88

LIGHTLINE LED 88 can be surface mounted or suspended from the ceiling. It consists of an aluminium extruded profile constructed as individual modules in various chassis lengths, which come complete with integral driver. Optical control is provided by a clip in opal diffuser. Finish in RAL 9010 as standard.
 High Efficient LED. Small tolerance of MacAdam 3. Long life 72,000 hours.

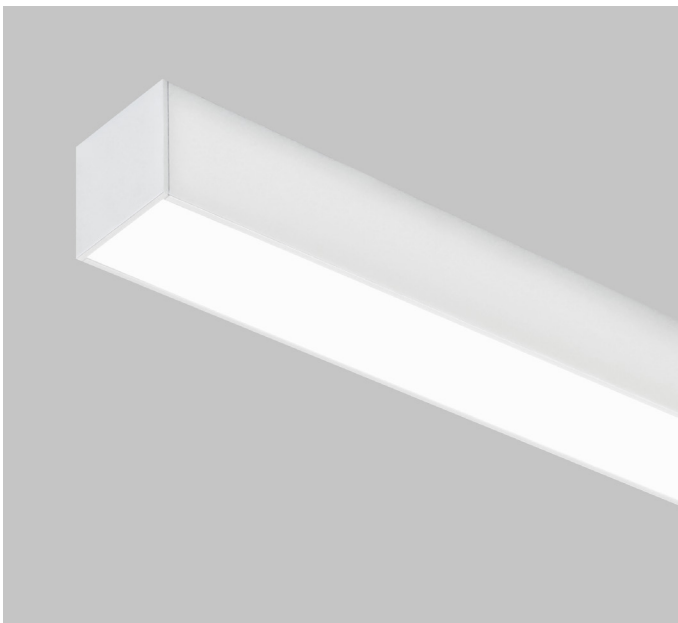

Construction	Aluminium / Steel / Plastic
Diffuser	Opal
Finish	White RAL 9010
IP	IP40
Control	Fixed, DALI, 1-10V

Product No	Length (mm)	Colour Temp	CRI	Source (Lm)	Wattage (W)	Current (mA)	System Efficacy (Lm/W)	Luminaire Efficacy (LLm/W)
L2202	580	3000K	>80	1170	7.2	300	162	102
L2203	860	3000K	>80	1755	10.8	300	162	102
L2204	1140	3000K	>80	2340	14.4	300	162	102
L2205	1420	3000K	>80	2925	18.0	300	162	102
L2206	1700	3000K	>80	3510	21.6	300	162	102
L2302	580	4000K	>80	1220	7.2	300	170	106
L2303	860	4000K	>80	1830	10.8	300	170	106
L2304	1140	4000K	>80	2440	14.4	300	170	106
L2305	1420	4000K	>80	3050	18.0	300	170	106
L2306	1700	4000K	>80	3660	21.6	300	170	106

Other finishes: X159 - Metallic Silver, X009- Black RAL 9006 (30% Gloss).

Tolerance range for optical and electrical data: ±10 %.
 Other outputs are available.