

LIGHTLINE LED 60

LIGHTLINE LED 60 can be surface mounted or suspended from the ceiling. It consists of an aluminium extruded profile constructed as individual modules in various chassis lengths, which come complete with integral driver. Optical control is provided by a clip in opal diffuser. Finish in RAL 9010 as standard.
High Efficient LED. Small tolerance of MacAdam 3. Long life 72,000 hours.

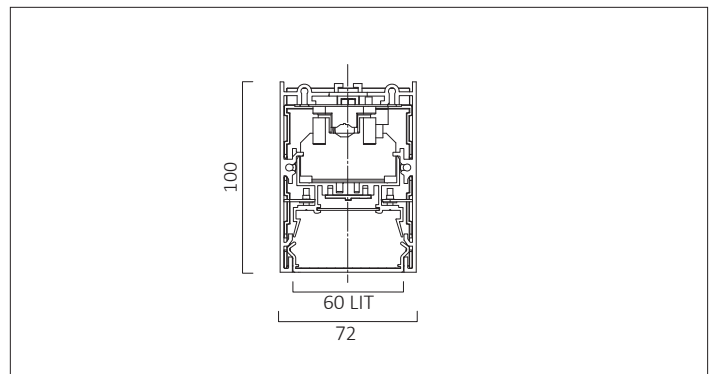
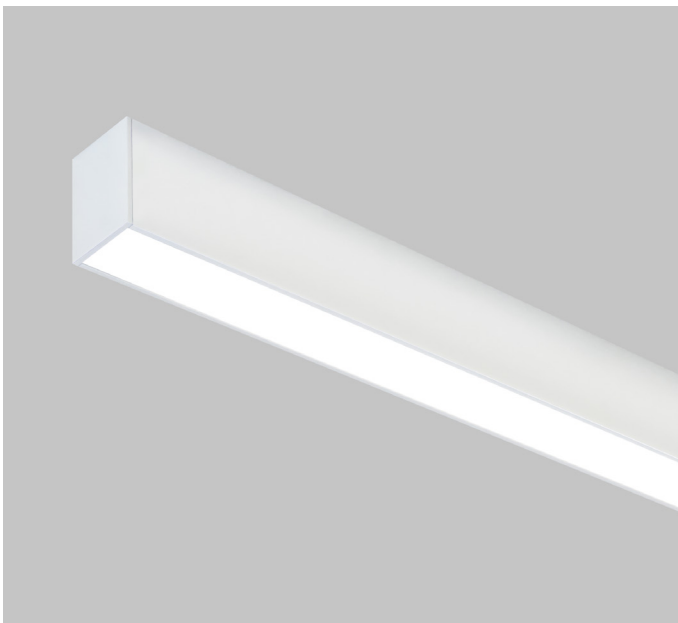

Construction	Aluminium / Steel / Plastic
Diffuser	Opal
Finish	White RAL 9010 (20% Gloss)
IP	IP40
Control	Fixed, DALI or 1-10V

Product No	Length (mm)	Colour Temp	CRI	Source (Lm)	Wattage (W)	Current (mA)	System Efficacy (Lm/W)	Luminaire Efficacy (LLm/W)
L1002	580	3000K	>80	1170	7.2	300	162	98
L1003	860	3000K	>80	1755	10.8	300	162	98
L1004	1140	3000K	>80	2340	14.4	300	162	98
L1005	1420	3000K	>80	2925	18.0	300	162	98
L1006	1700	3000K	>80	3510	21.6	300	162	98
L1102	580	4000K	>80	1220	7.2	300	170	102
L1103	860	4000K	>80	1830	10.8	300	170	102
L1104	1140	4000K	>80	2440	14.4	300	170	102
L1105	1420	4000K	>80	3050	18.0	300	170	102
L1106	1700	4000K	>80	3660	21.6	300	170	102

Other finishes: X159 - Metallic Silver, X009- Black RAL 9005 (30% Gloss).

Tolerance range for optical and electrical data: $\pm 10\%$.
Other outputs are available.