

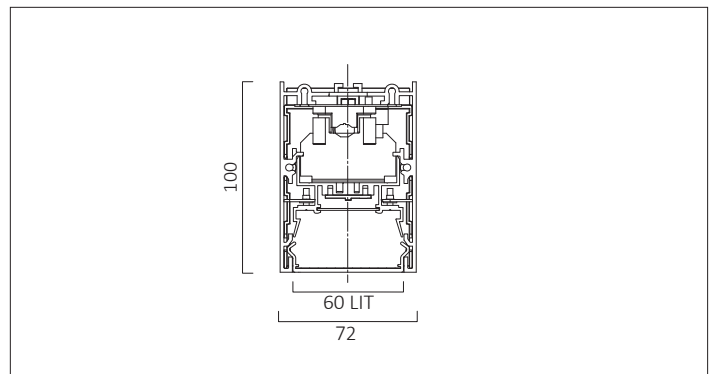

LIGHTLINE LED 60

LIGHTLINE LED 60 can be surface mounted or suspended from the ceiling. It consists of an aluminium extruded profile constructed as individual modules in various chassis lengths, which come complete with integral driver. Optical control is provided by a clip in opal diffuser. Finish in RAL 9010 as standard.
High Efficient LED. Small tolerance of MacAdam 3. Long life 72,000 hours.

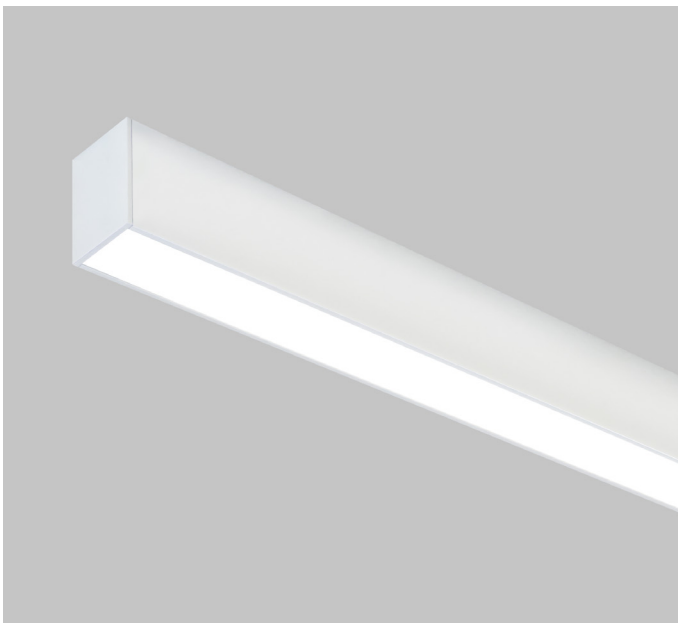

Construction	Aluminium / Steel / Plastic
Diffuser	Opal
Finish	White RAL 9010 (20% Gloss)
IP	IP40
Control	Fixed, DALI or 1-10V

Product No	Length (mm)	Colour Temp	CRI	Source (Lm)	Wattage (W)	Current (mA)	System Efficacy (Lm/W)	Luminaire Efficacy (LLm/W)
L1202	580	3000K	>80	2260	13.2	300	162	98
L1203	860	3000K	>80	3390	19.8	300	162	98
L1204	1140	3000K	>80	4520	26.4	300	162	98
L1205	1420	3000K	>80	5650	33.0	300	162	98
L1206	1700	3000K	>80	6780	39.6	300	162	98
L1302	580	4000K	>80	2340	13.2	300	170	102
L1303	860	4000K	>80	3510	19.8	300	170	102
L1304	1140	4000K	>80	4680	26.4	300	170	102
L1305	1420	4000K	>80	5850	33.0	300	170	102
L1306	1700	4000K	>80	7020	39.6	300	170	102

Other finishes: X159 - Metallic Silver, X009- Black RAL 9005 (30% Gloss).

Tolerance range for optical and electrical data: $\pm 10\%$.
Other outputs are available.