

MINITRIM 62 SINGLE KICK WALLWASHER

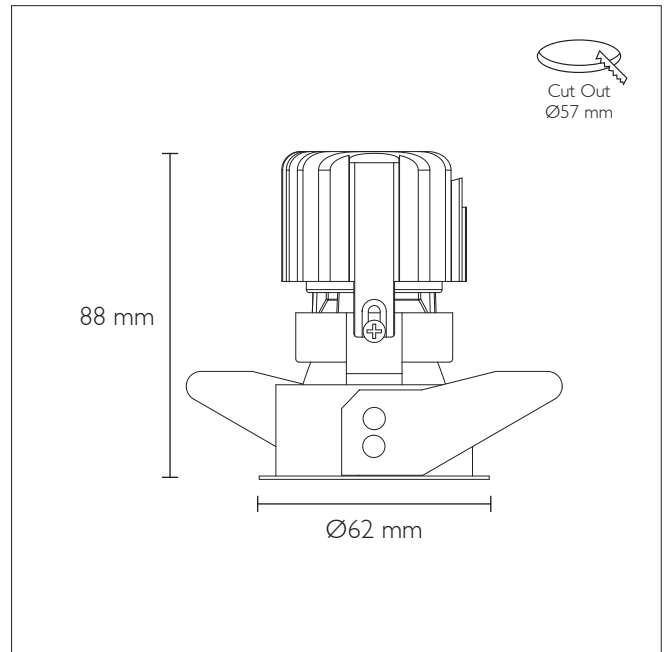
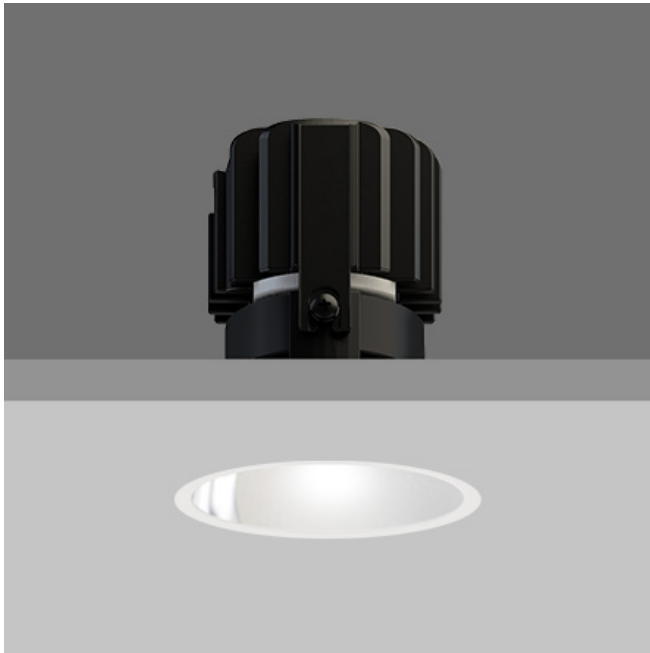
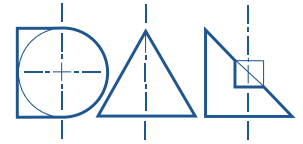

WALLWASH MODULE

CREE Lighting Engine - CRI 90, 2-Step MacAdam
2200K / 2700K / 3000K / 4000K

Tested with CREE 4000K (System: 13.0 W / 300 mA)

Source Lumens	System Wattage	Delivered Lumens	Efficacy (LOR 75%)
Wallwash			
700 lm	7.2 W	525 lm	72 lm/W
1000 lm	10.9 W	750 lm	68 lm/W
1300 lm	14.7 W	975 lm	66 lm/W

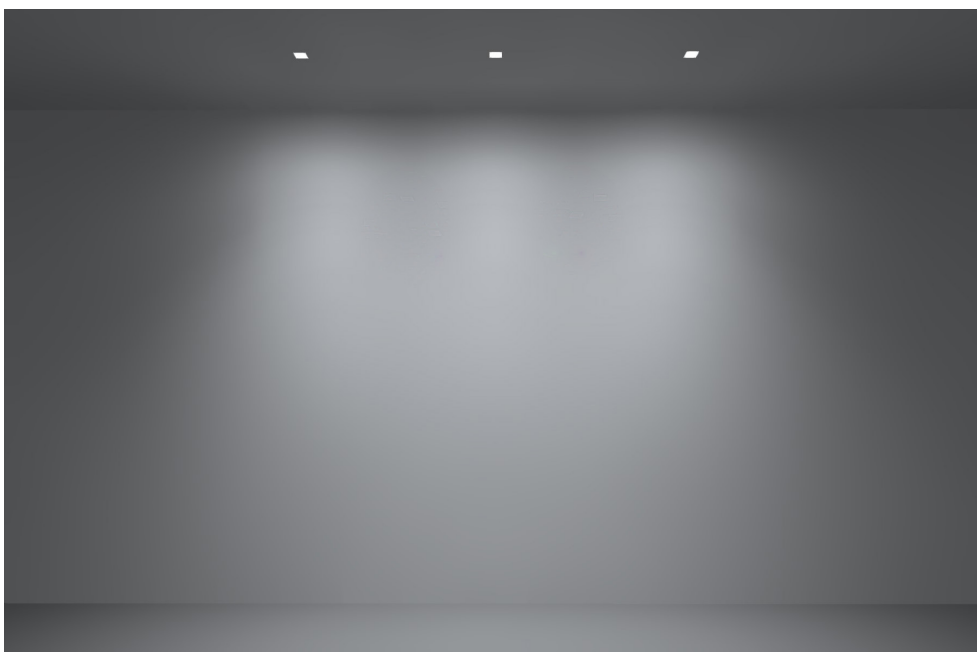
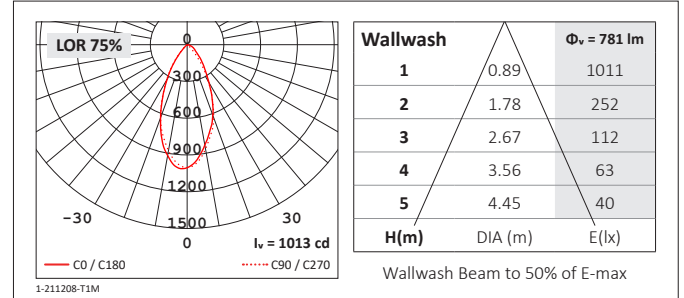

* Simulation for reference only

WALLWASH PLACEMENT

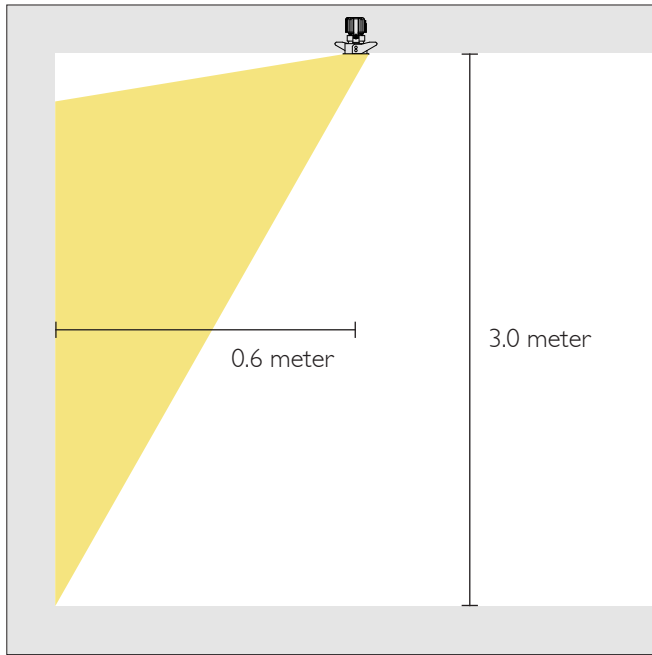

Suggested mounting distance from downlight center to wall of MINITRIM 62 Single Kick Wallwasher is 0.7 meter, ceiling height 3 meter.

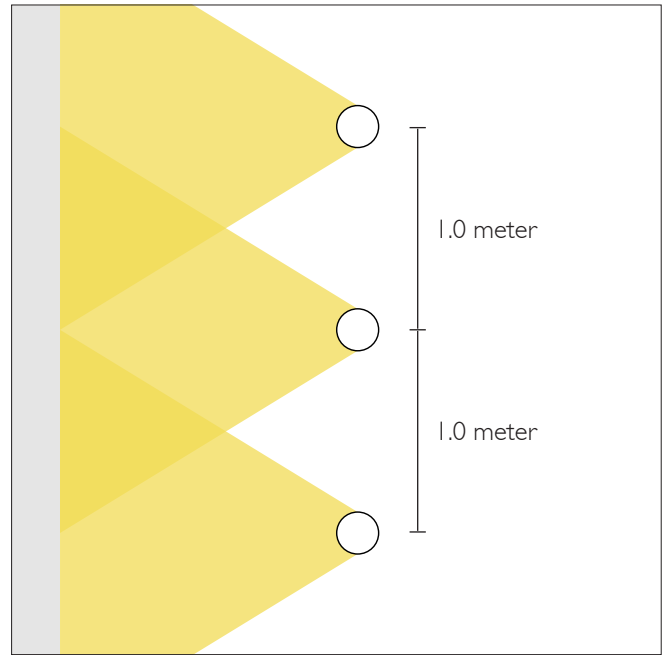

Suggested downlight center spacing of the MINITRIM 62 Single Kick Wallwasher is 1.2 meter. Wallwash kicker must be oriented parallel with wall.

REFLECTOR COLOUR

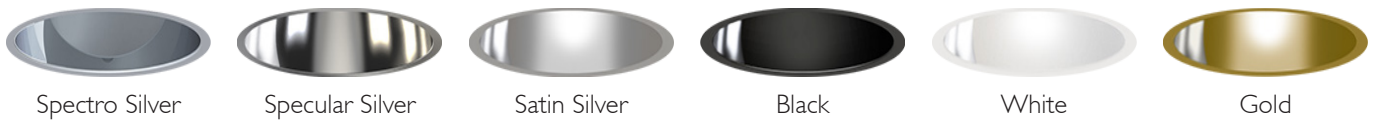

PRODUCT CODING EXAMPLE - F880113J550

Series	Beam	Reflector Colour	Source Lumens	LED	CCT	Driver Protocol	Emergency Protocol
F88 IP20 F89 IP44	0 Wallwash	1 Specular Silver 2 Satin Silver 3 Black 4 White 5 Gold 8 Spectro Silver	07 700 lm 10 1000 lm 13 1300 lm	J Cree	1 2200K 2 2700K 3 3000K 5 4000K	0 Fixed 1 1-10V 5 DALI 7 Lead / Trail 9 Addressable	0 None E Emergency N Non-maintained
F88	0	1	13	J	5	5	0

- CRI 98 CREE Lighting engine is available on request
- Tolerance range for optical and electrical data shown in this datasheet: ±5%