

MINITRIM 62 CORNER KICK WALLWASHER

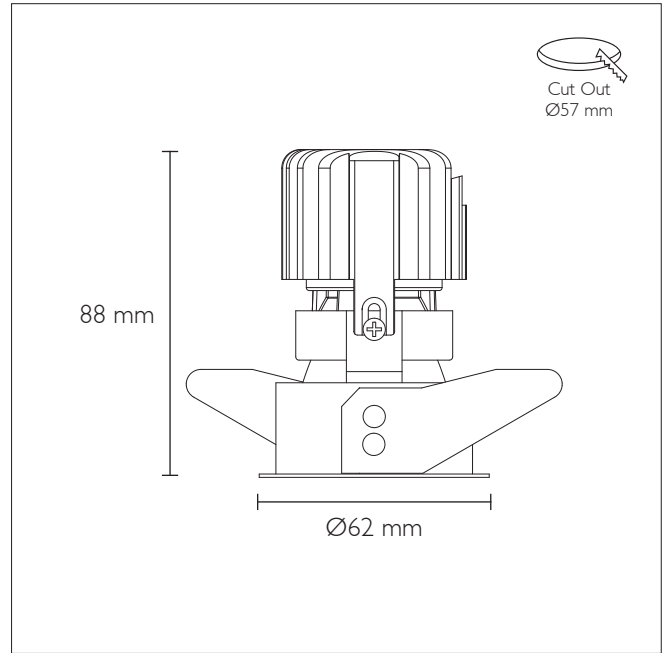
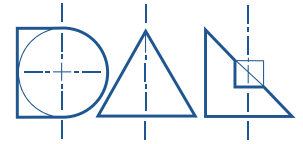

WALLWASH MODULE

CREE Lighting Engine - CRI 90, 2-Step MacAdam
2200K / 2700K / 3000K / 4000K

Tested with CREE 2700K (System: 13.0 W / 300 mA)

Source Lumens	System Wattage	Delivered Lumens	Efficacy (LOR 76%)
Wallwash			
700 lm	7.2 W	532 lm	73 lm/W
1000 lm	10.9 W	760 lm	69 lm/W
1300 lm	14.7 W	988 lm	67 lm/W

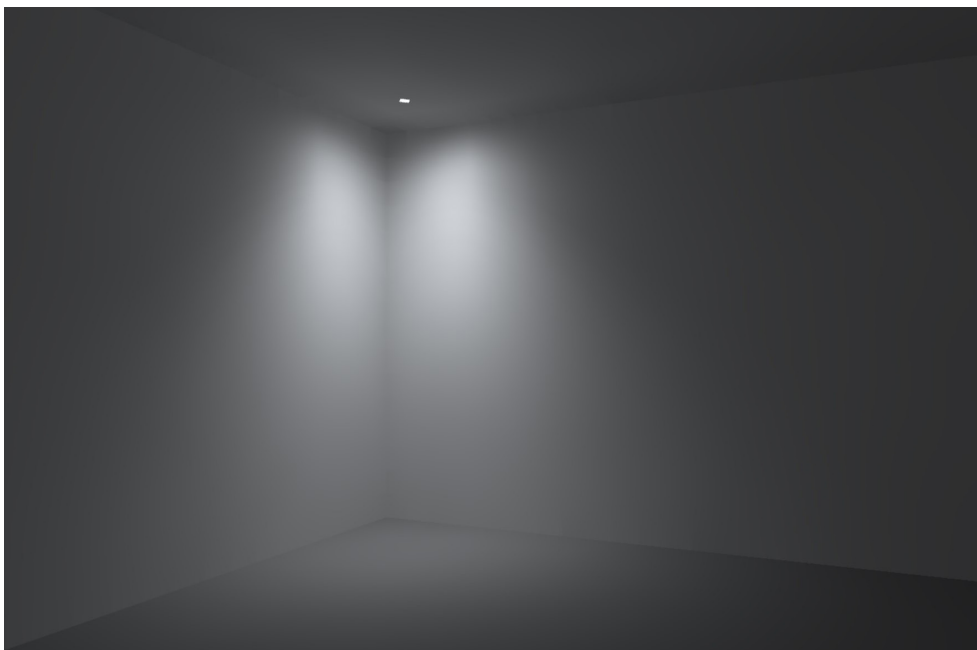
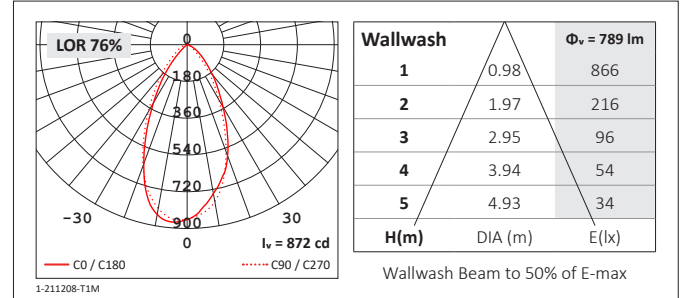

* Simulation for reference only

WALLWASH PLACEMENT

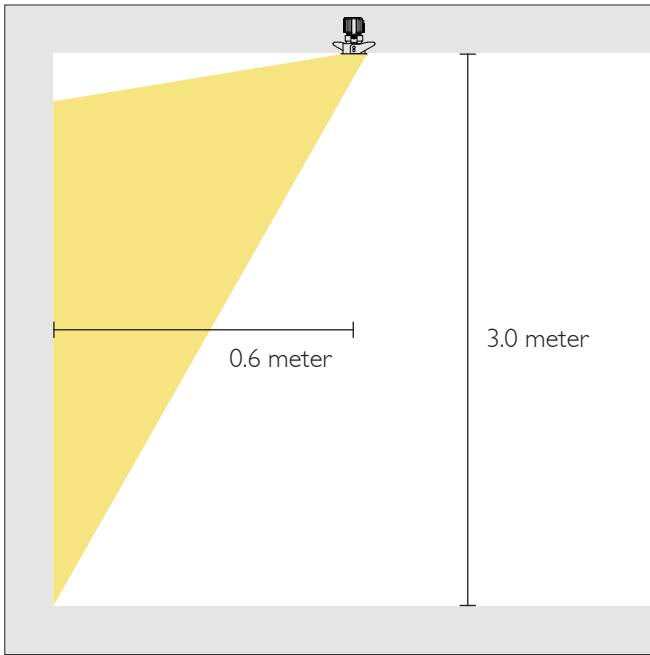

Suggested mounting distance from downlight center to corner of MINITRIM 62 Corner Kick Wallwasher is 0.7 meter; ceiling height 3 meter.

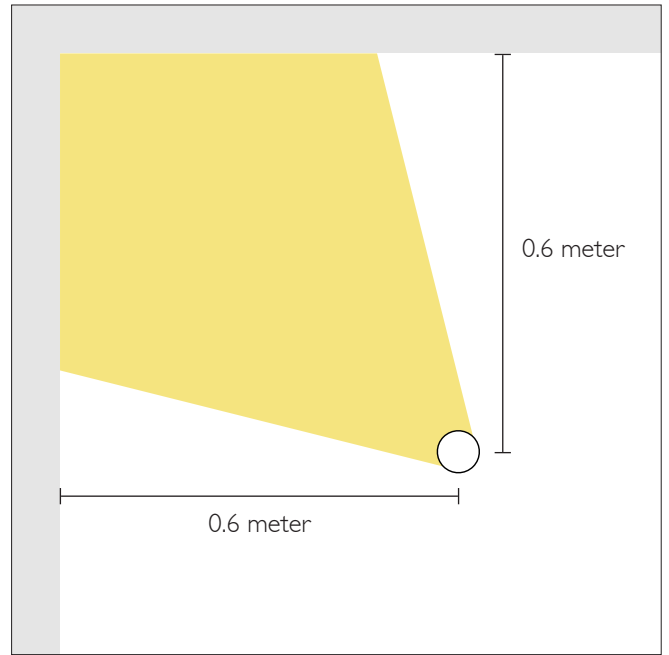

Suggested distance from downlight center to corner walls of the MINITRIM 62 Corner Kick Wallwasher is 0.7 meter. Wallwash kicker must be faced direct to corner.

REFLECTOR COLOUR

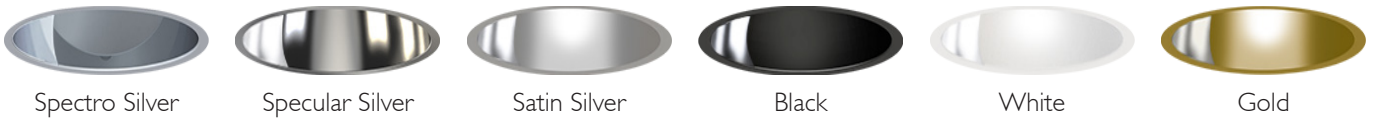

PRODUCT CODING EXAMPLE - F940113J550

Series	Beam	Reflector Colour	Source Lumens	LED	CCT	Driver Protocol	Emergency Protocol
F94 IP20 F95 IP44	0 Wallwash	1 Specular Silver 2 Satin Silver 3 Black 4 White 5 Gold 8 Spectro Silver	07 700 lm 10 1000 lm 13 1300 lm	J Cree	1 2200K 2 2700K 3 3000K 5 4000K	0 Fixed 1 1-10V 5 DALI 7 Lead / Trail 9 Addressable	0 None E Emergency N Non-maintained
F94	0	1	13	J	5	5	0

- CRI 98 CREE Lighting engine is available on request
- Tolerance range for optical and electrical data shown in this datasheet: ±5%